

ECHELON

CASE STUDY // AGAVE



JUNE 1, 2021

PROBABILISTIC FORECASTS
ON MULTI-MILLION CELL
COMPOSITIONAL MODELS
BECOMES ROUTINE

2.4M

ACTIVE CELLS

35 yrs

FORECAST

**Compositional 11
components**

FLUID TYPE

ECHELON CASE STUDY: AGAVE

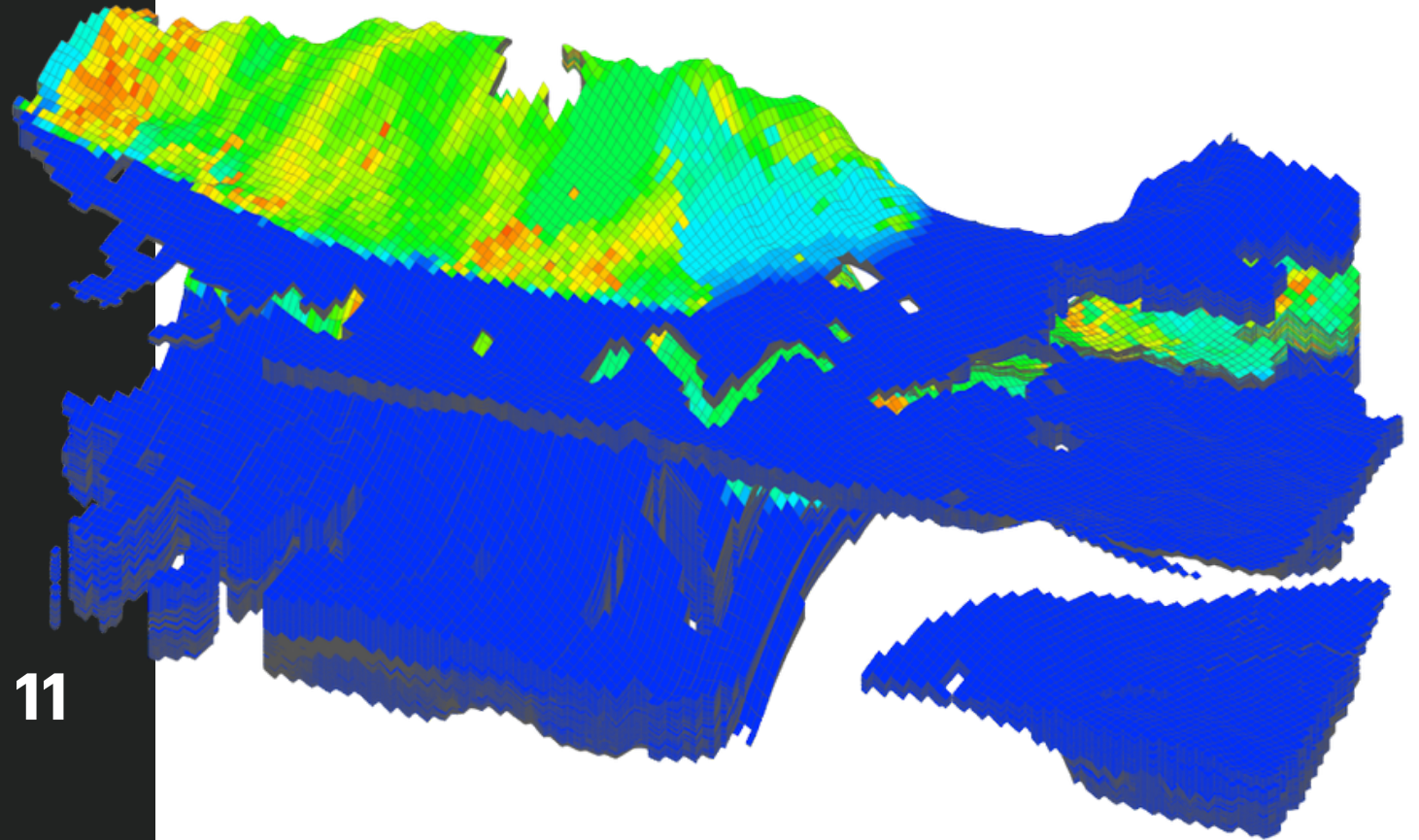

Initial water saturation in a sector of the Agave model, for illustration. The results presented in this case have been obtained with the full-field model.



CHALLENGE

Agave is a light-oil, deep-water field with early production history. Evaluating the risks associated with the proposed development strategy called for the generation of a probabilistic forecast (or risk analysis) starting from an ensemble of 150 history-matched models.

The models feature 2.4M active cells and two equations of state regions with 11 hydrocarbon components each. They are run without relaxing the convergence criteria.

The development plan is based on produced water and gas reinjection in the form of WAG (water-alternating-gas) injection cycles, taking into account production constraints such as maximum liquid production and water treatment capacity.

The challenge is to simulate Agave in a sufficiently short time-frame for the ensemble of 150 forecast runs to complete over one week-end with a maximum of 50 nodes of Eni's HPC5 supercomputer.



SOLUTION

The solution is to use ECHELON 2.0, the first compositional simulator developed from the ground up to run on Graphics Processing Units (GPUs).

ECHELON 2.0 is commercialized with fully implicit (FIM) and adaptive implicit (AIM) formulations, and supports most reservoir and field management options available in legacy reservoir simulators.

A scalability test shows that a good compromise between raw simulation speed and optimization of resources is to run each model in parallel on four GPUs, i.e., one node.

Comparing the simulated field GOR between all the considered GPU configurations shows that results are unaffected, highlighting the robustness of ECHELON's compositional solver and strengthening the engineer's confidence in the quality of the results.

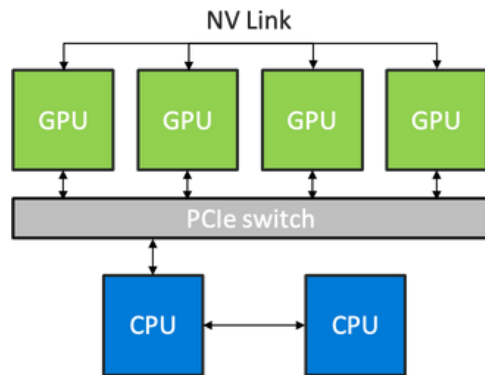

Each node of the HPC5 supercomputer is equipped with 2 Intel Gold 6252 24-core CPUs and 4 NVIDIA V100 GPU accelerators.

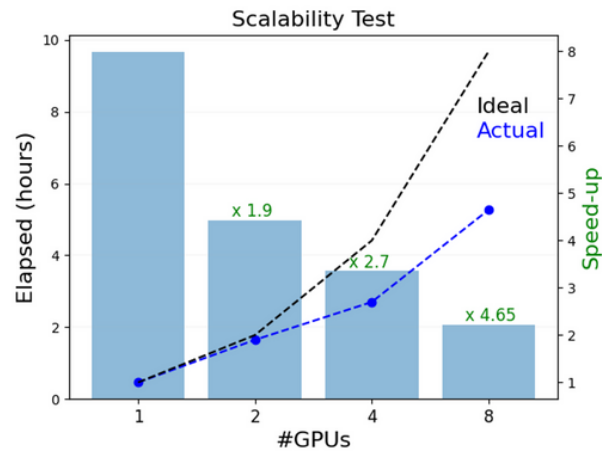

Scalability test of a representative element of the ensemble, run in fully-implicit mode, showing outstanding performance with Strong scaling from 1 to 2 GPUs at 1.9x.

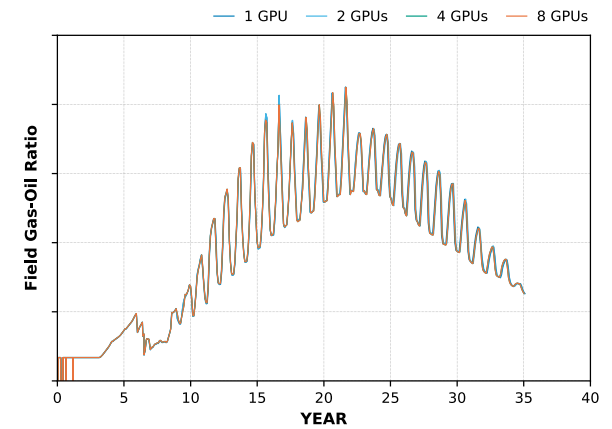

Simulated field GOR is identical for all the GPU configurations considered, highlighting the robustness of ECHELON's compositional solver.

RESULTS

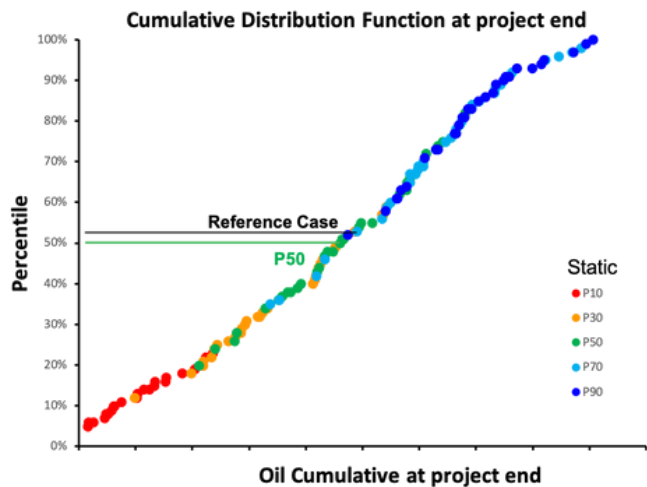
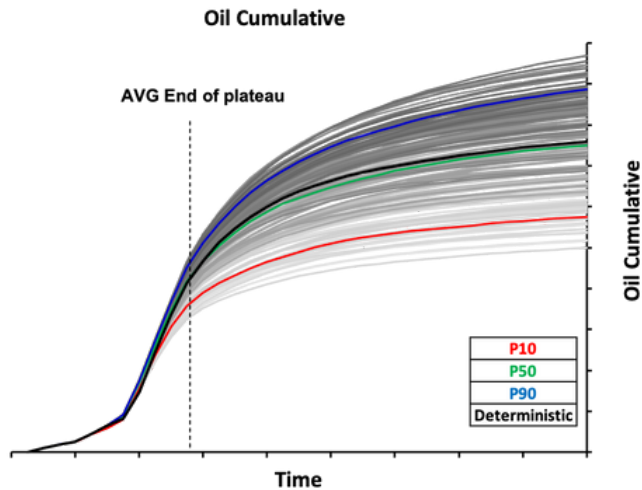

Top: Overlay of cumulative oil production profiles for the 150 cases, with the reference case and three percentiles. Bottom: Cumulative distribution percentiles for the same 150 cases, colored per initial oil in place percentiles.

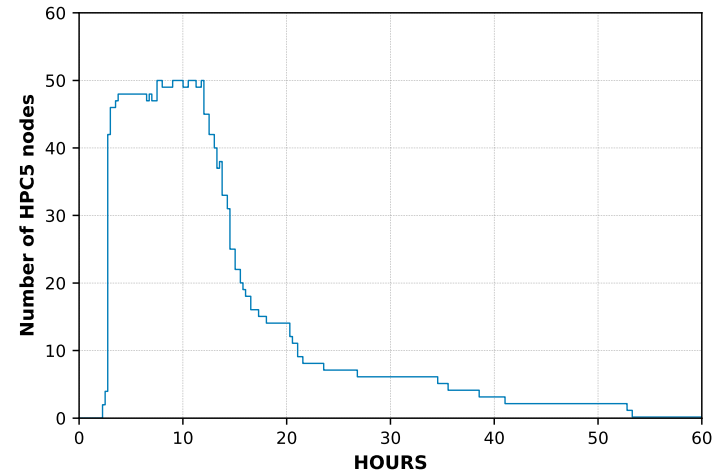

HPC5 workload for the Agave risk analysis, measured in number of HPC5 nodes. Runs were initially queued to limit resource usage in order to leave breathing room for possible last-minute manual submissions.

The main deliverables of the risk analysis were the cumulative oil production at the end of plateau and the end of field life. Distributions were then used to assemble the technical reserves. The runs were submitted during the week-end, aiming at using a maximum of 50 nodes out of the 57 nodes dedicated to the deepwater area asset team. Most realizations took less than four hours, while some outliers with specific combinations of parameters took up to ten hours, yielding a tail in the simulation workload. In summary, ECHELON was able to run a full Monte Carlo risk analysis on a complex compositional model over the week-end.



STONERIDGETECHNOLOGY.COM